

Sheet	COUNTY	ROUTE	POST MILES	TOTAL SHEETS
REGISTERED CIVIL ENGINEER 				
PLANS APPROVAL DATE: May 31, 2018 I, ROBERT J. B... , REGISTERED CIVIL ENGINEER, STATE OF CALIFORNIA, LICENSE NO. 122000, HEREBY CERTIFY THAT THE ABOVE PLANS WERE PREPARED BY ME OR UNDER MY CLOSE PERSONAL SUPERVISION AND THAT I AM AWARE OF ALL THE REQUIREMENTS OF THE CALIFORNIA ENGINEERING ACT AND REGULATIONS.				

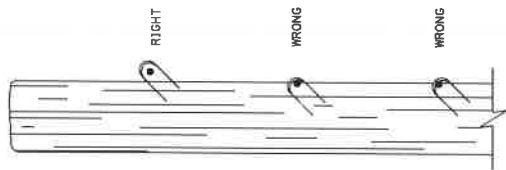

DRIVE STAPLES AT ANGLE

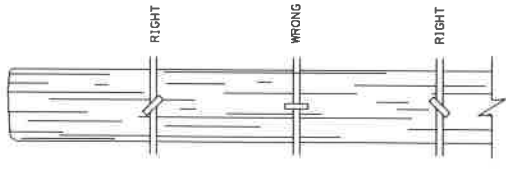

DO NOT DRIVE STAPLES PARALLEL TO SIDE OF POST

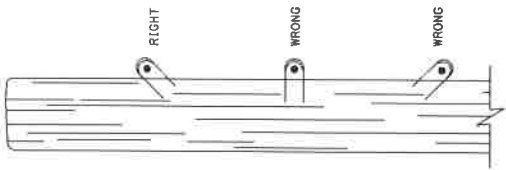

LEAVE WIRE LOOSE IN STAPLE

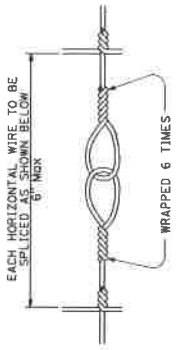

SPLICE DETAIL FOR BARBED WIRE/WIRE MESH FENCE

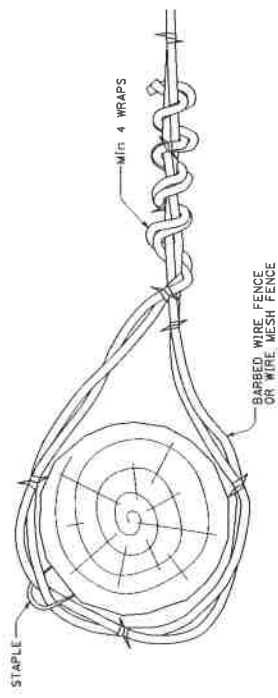

END LATCH, PULL, AND CORNER POST DETAIL
(Also applies to rectangular/square posts)

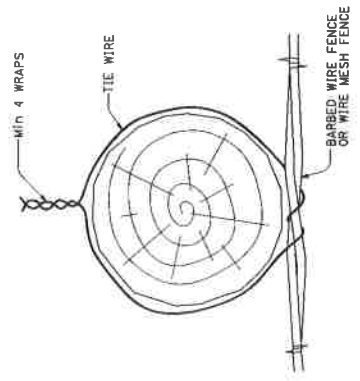

OPTION B

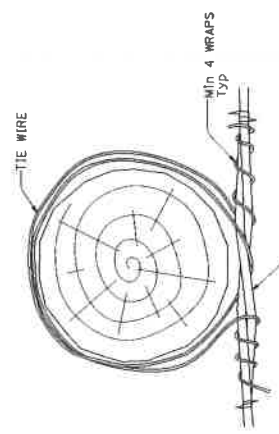

OPTION A

LINE POST WIRE TIE OPTION DETAILS
(option details also apply to rectangular/square posts)

STATE OF CALIFORNIA
 DEPARTMENT OF TRANSPORTATION
BARBED WIRE AND WIRE MESH FENCE - MISCELLANEOUS DETAILS
 NO SCALE
A86D